

Technical Drawings

FRAME PROFILE		
5201		
	Thickness	Weight-kg/m
U - Reinforcement steel DS 01011	1.25mm	0.634
	1.55mm	0.778
	2.05mm	1.020
Box Reinforcement steel DS 01011-K	1.25mm	
	1.55mm	1.024
	2.05mm	1.319

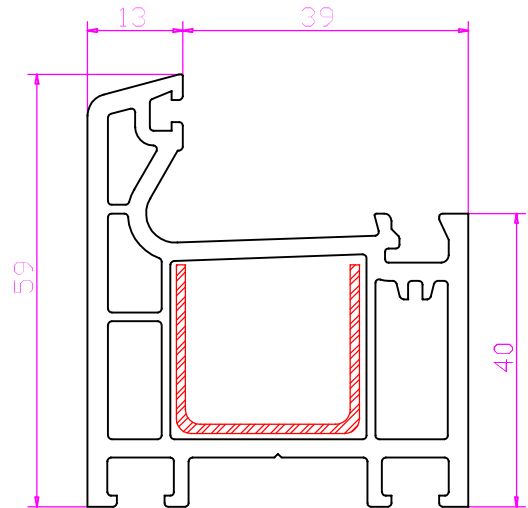

BAHAR FRAME PROFILE	
5201 EU-B	

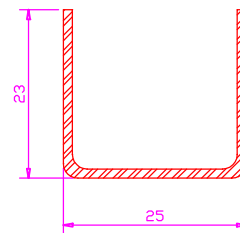
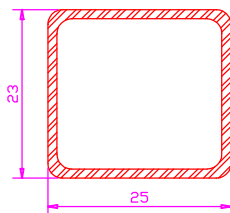
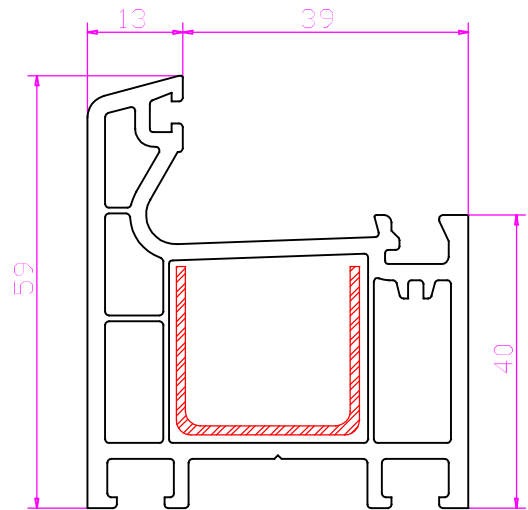

SASH PROFILE

5202

	Thickness	Weight-kg/m
U - Reinforcement steel	1.25mm	0.546
	1.55mm	0.670
DS 01012	2.05mm	0.832

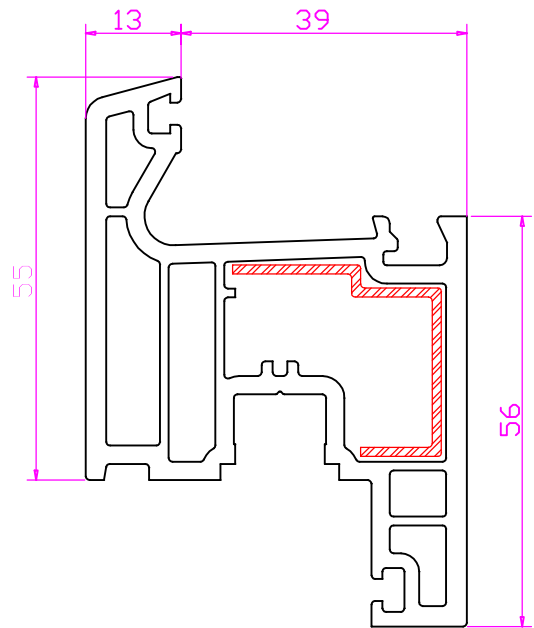

BAHAR SASH PROFILE

5202 EU-B

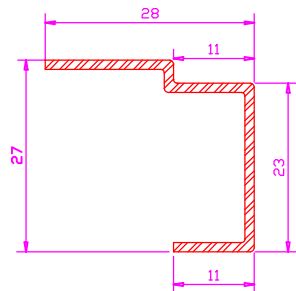
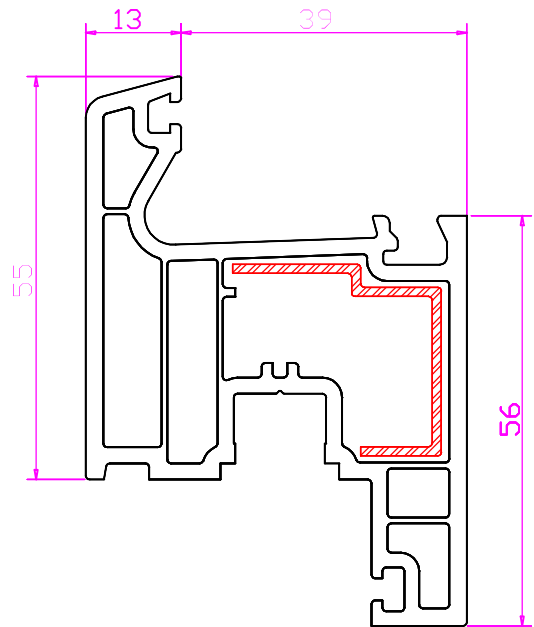

5200 SYSTEM & BAHAR SERIES

NEW SASH PROFILE

5212

	Thickness	Weight-kg/m
U - Reinforcement steel	1.25mm	0.634
	1.55mm	0.778
DS 01012	2.05mm	1.020

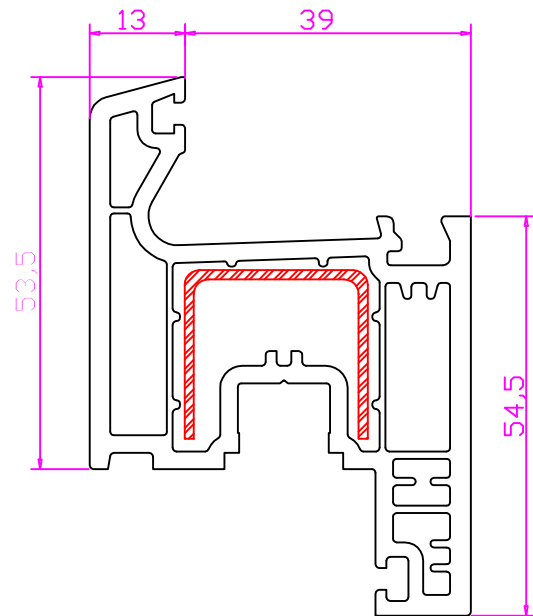

NEW BAHAR SASH PROFILE

5212 EU-B

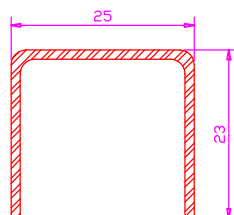
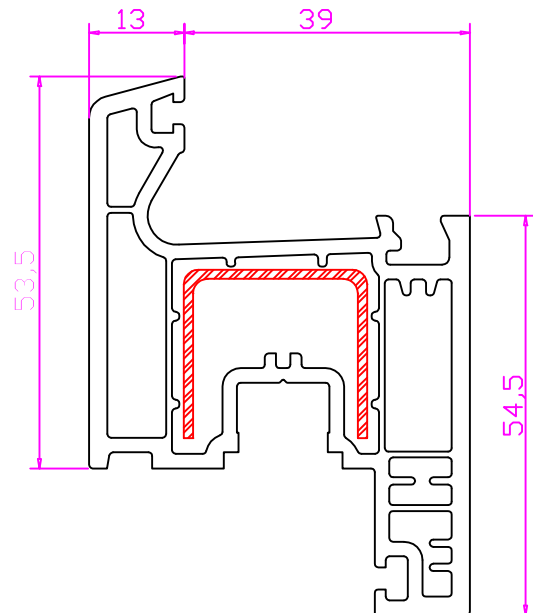

MULLION PROFILE

5203

	Thickness	Weight-kg/m
U - Reinforcement steel DS 01011	1.25mm	0.634
	1.55mm	0.778
	2.05mm	1.020
Box Reinforcement steel DS 01011-K	1.25mm	
	1.55mm	1.024
	2.05mm	1.319

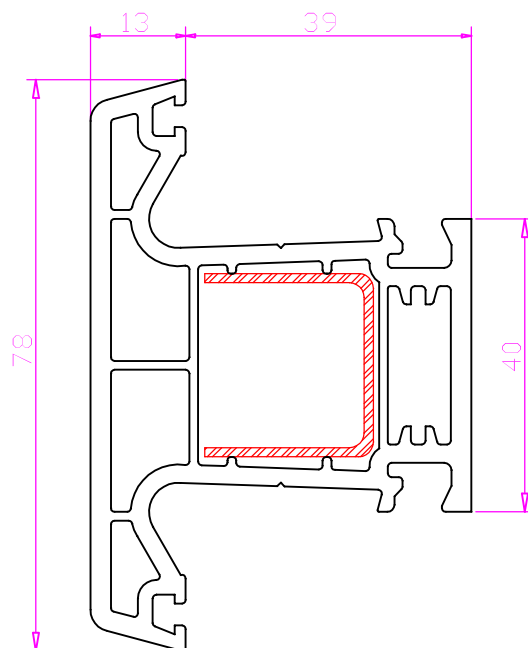

BAHAR MULLION PROFILE

5203 EU-B

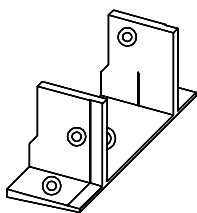
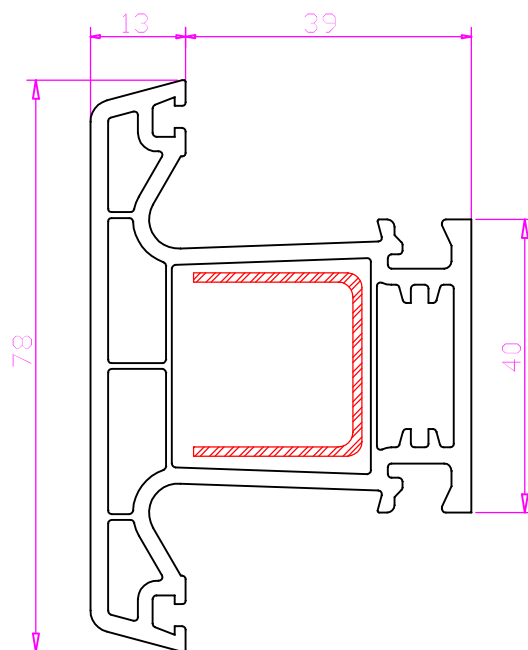

OB01004

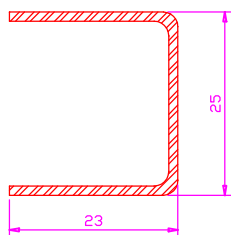
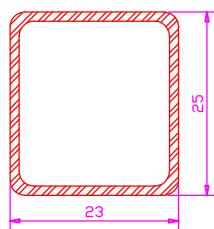

DOOR SASH PROFILE (INW. OPENING)

5204

	Thickness	Weight-kg/m
U - Reinforcement steel DS 01013	1.25mm	1.642
	1.55mm	2.022
	2.05mm	2.640
Box Reinforcement steel DS 01013-K	1.25mm	1.516
	1.55mm	1.889
	2.05mm	2.464

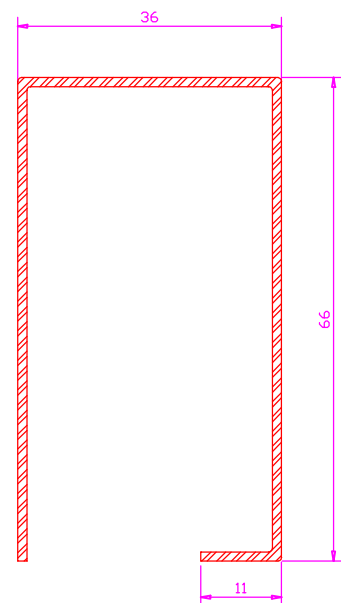
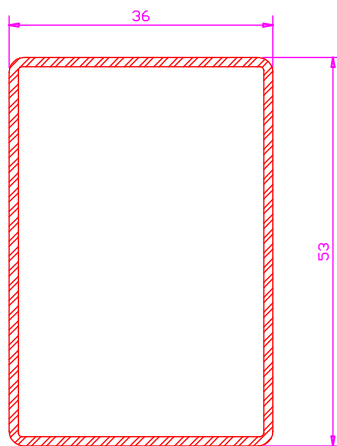
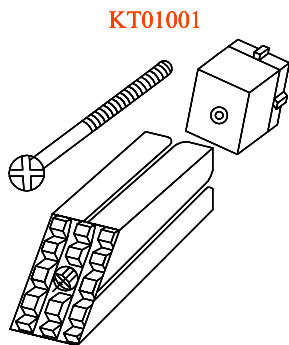
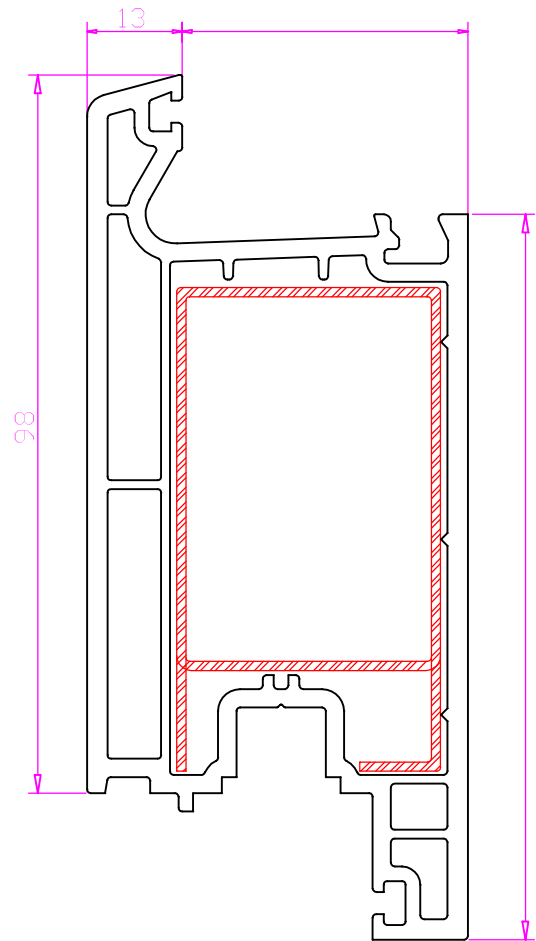

DOOR SASH PROFILE (OUTW. OPENING)

5210

	Thickness	Weight-kg/m
U - Reinforcement steel DS 01025	1.25mm	1.115
	1.55mm	1.330
	2.05mm	1.740
Box Reinforcement steel DS 01025-K	1.25mm	1.050
	1.55mm	1.240
	2.05mm	1.590

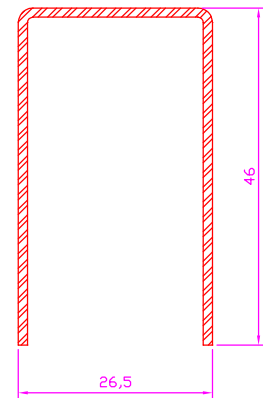
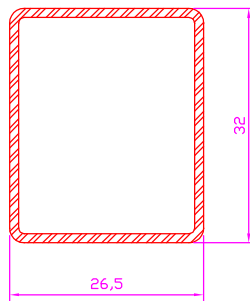
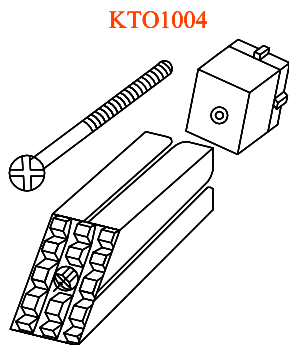
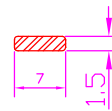
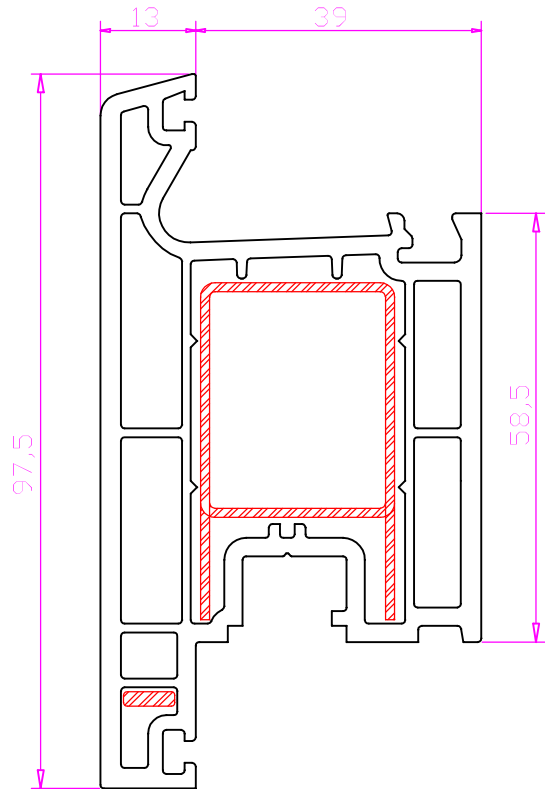

SINGLE GLAZING BEAD (6 mm)

5205

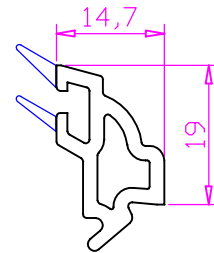
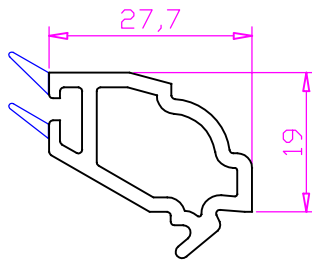

SINGLE GLAZING BEAD (4 mm)

5211

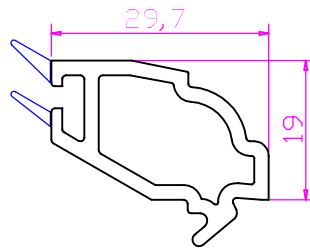

DOUBLE GLAZING BEAD (20mm)

5206

OUTWARD OPENING WINDOW SASH

5209

	Thickness	Weight-kg/m
U - Reinforcement steel	1.25mm	0.634
	1.55mm	0.778
	2.05mm	1.020
DS 01011		

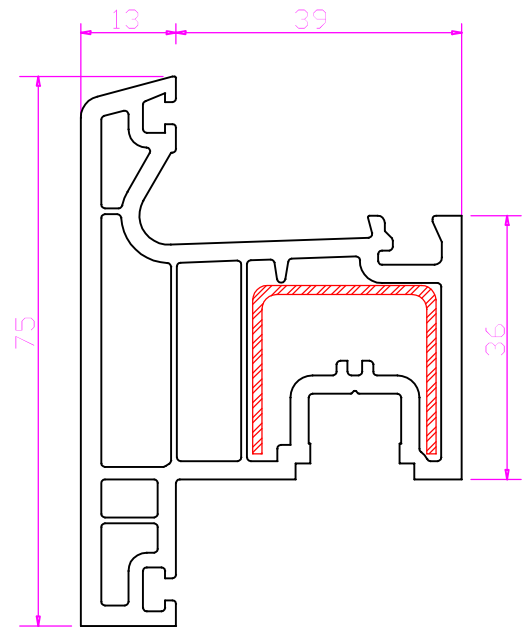

REBATE REVERSER PROFILE

5207

	Thickness	Weight-kg/m
U - Reinforcement steel	1.25mm	0.634
	1.55mm	0.778
	2.05mm	1.020
DS 01011		
	1.25mm	
	1.55mm	1.024
Box Reinforcement steel	1.55mm	1.024
	2.05mm	1.319
DS 01011-K		

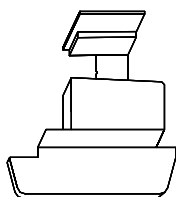
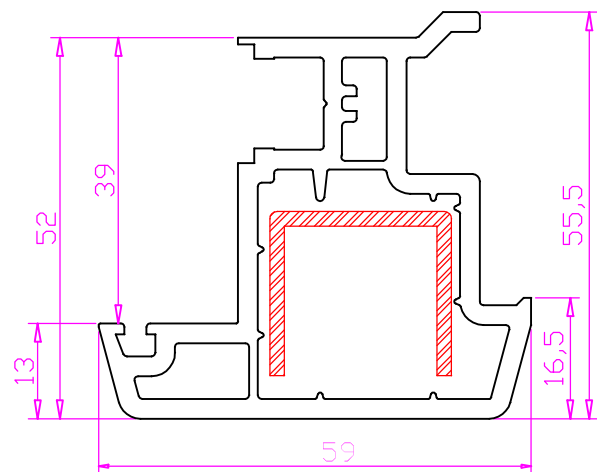

DA01008

